

DRAUFSICHT
Schalungsstein

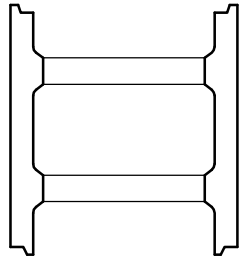

ANSICHT

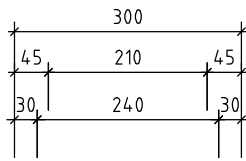
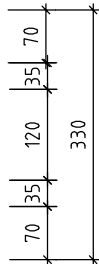

ANSICHT
Schalungsstein

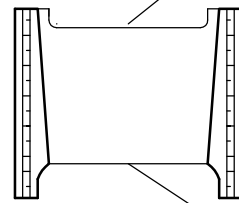
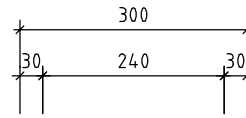

Aussparungsgröße
ca. 50 cm²

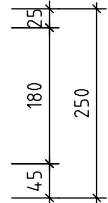

Aussparungsgröße
ca. 100 cm²

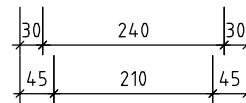

DRAUFSICHT
Endstein

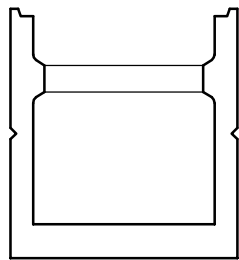
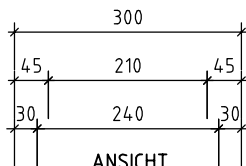

ANSICHT



ANSICHT
Endstein

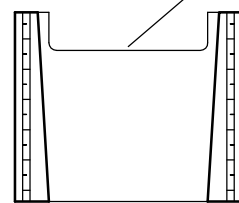
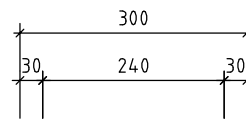

Aussparungsgröße
ca. 100 cm²

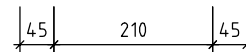
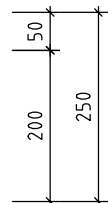

| | |
|---|-------------|
| Abmessung b/l/h mm | 300/330/250 |
| Druckfestigkeit in N/mm ² | ≥ 20 |
| Rohdichte in kg/dm ³ | 1,4 |
| Stück/Pal. | 48 |
| kg/Stück | 20,0 |
| Stück/m ² | 12 |
| Stück/m ³ | 40 |
| Betonbedarf in l/m ² | 170 |

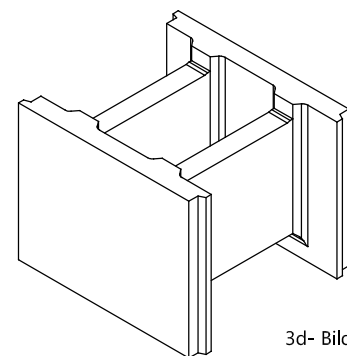

3d- Bild

| | | |
|--|---|---|
| Hersteller : Betonwerk Martin Hansky Crostwitzer Straße 1 01920 Höflein | Plan : Draufsichten und Ansichten Stein 30 cm | Maßstab : 1:10 |
| | | |
| | Prietitzer Straße 2d D-01920 Elstro OT Kriepitz | Tel.: 03 57 93 / 4 57 30 Fax: 03 57 93 / 4 57 31 |