

DRAUFSICHT
Schalungsstein

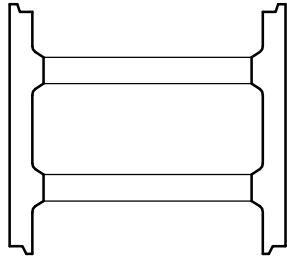

ANSICHT

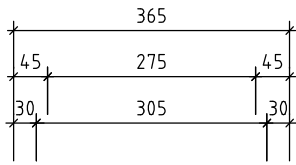
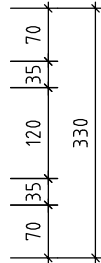

ANSICHT
Schalungsstein

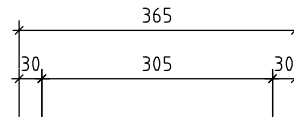

Aussparungsgröße
ca. 70 cm²

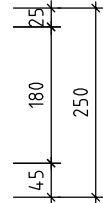
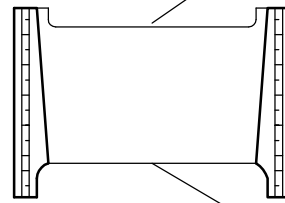

Aussparungsgröße
ca. 130 cm²

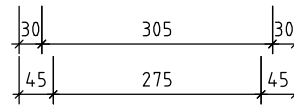

DRAUFSICHT
Endstein

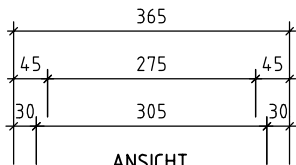

ANSICHT

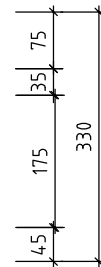
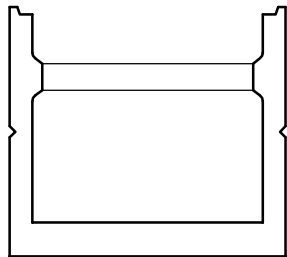

ANSICHT
Endstein

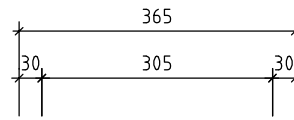

Aussparungsgröße
ca. 130 cm²

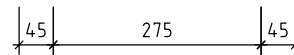
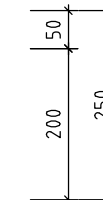
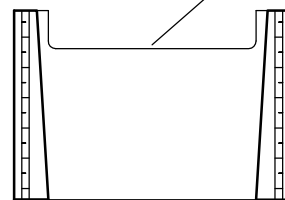

Abmessung b/l/h mm	365/330/250
Druckfestigkeit in N/mm ²	≥ 20
Rohdichte in kg/dm ³	1,4
Stück/Pal.	48
kg/Stück	22,0
Stück/m ²	12
Stück/m ³	33
Betonbedarf in l/m ²	240

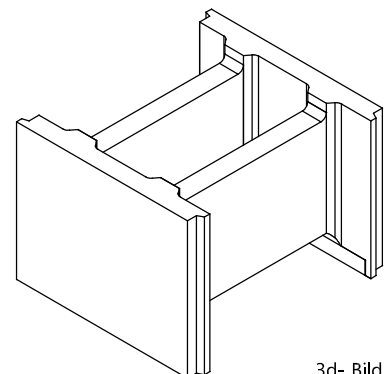

3d- Bild

Hersteller : Betonwerk Martin Hansky Crostwitzer Straße 1 01920 Höflein	Plan : Draufsichten und Ansichten Stein 36,5 cm	Maßstab : 1:10
	DIPL.-ING. ROBERTO KORENG INGENIEURBÜRO FÜR TRAGWERKSPLANUNG	
	Prietitzer Straße 2d D-01920 Elstro OT Kriepitz	Tel.: 03 57 93 / 4 57 30 Fax: 03 57 93 / 4 57 31